

Personalised Learning



Craig Smith
Aspect Hunter School

Global Accessibility Awareness Day

Craig Smith
Aspect Hunter School



How do we best reach
all learners?

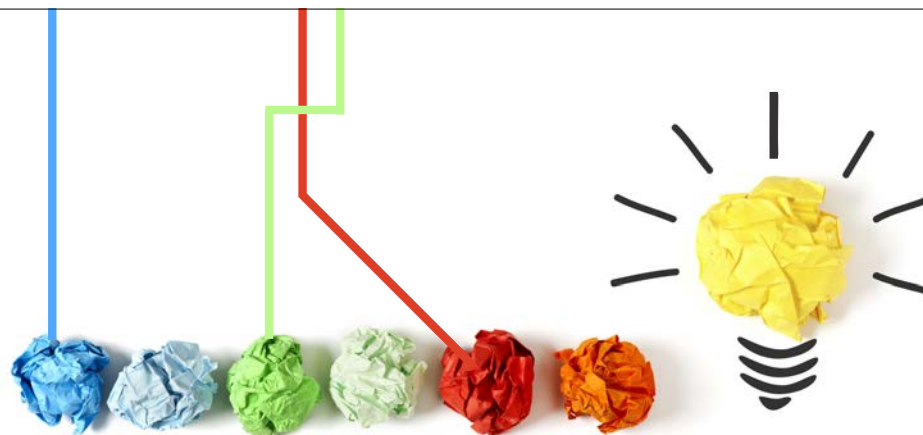

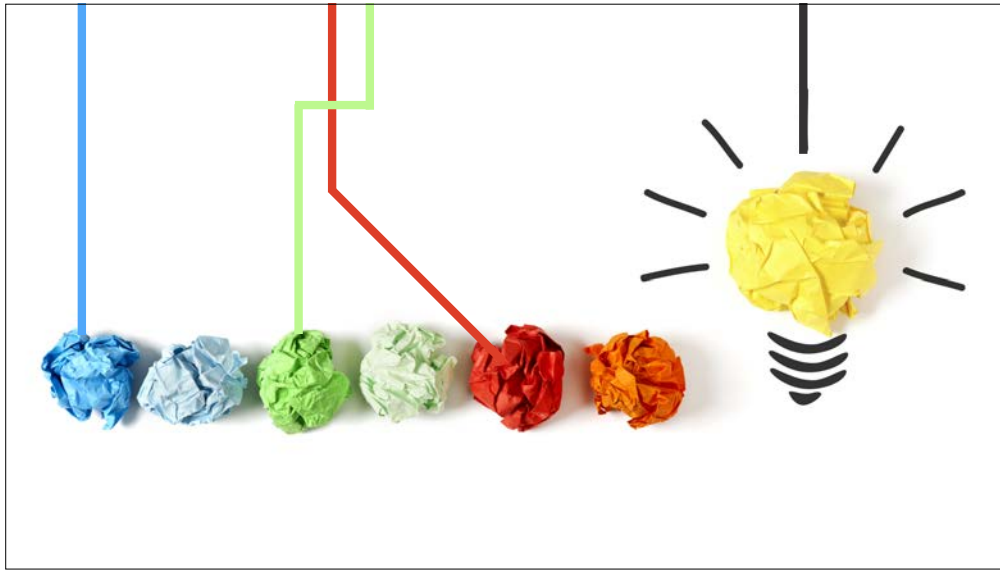



X 14000

Average Pilot Size



There is no average pilot size

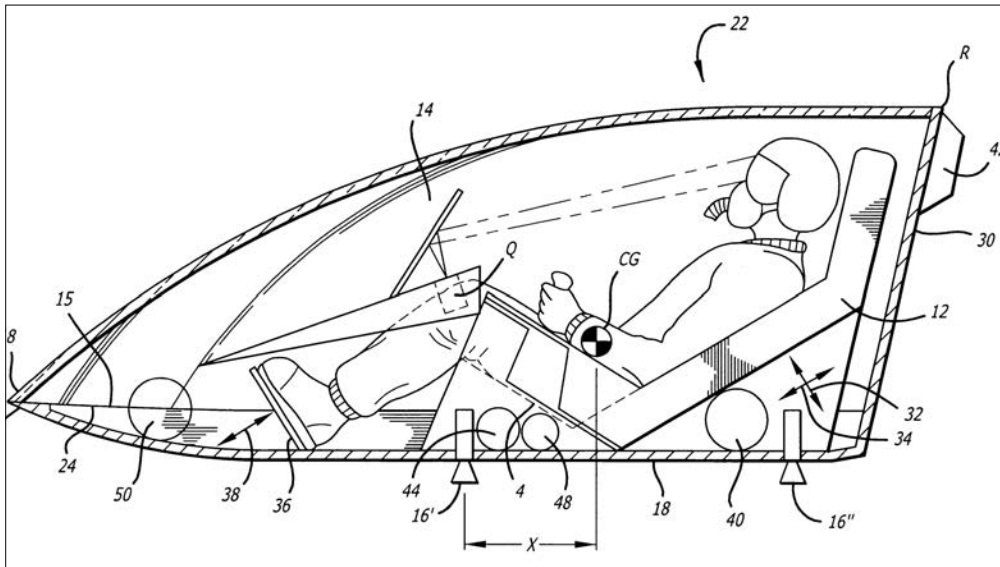

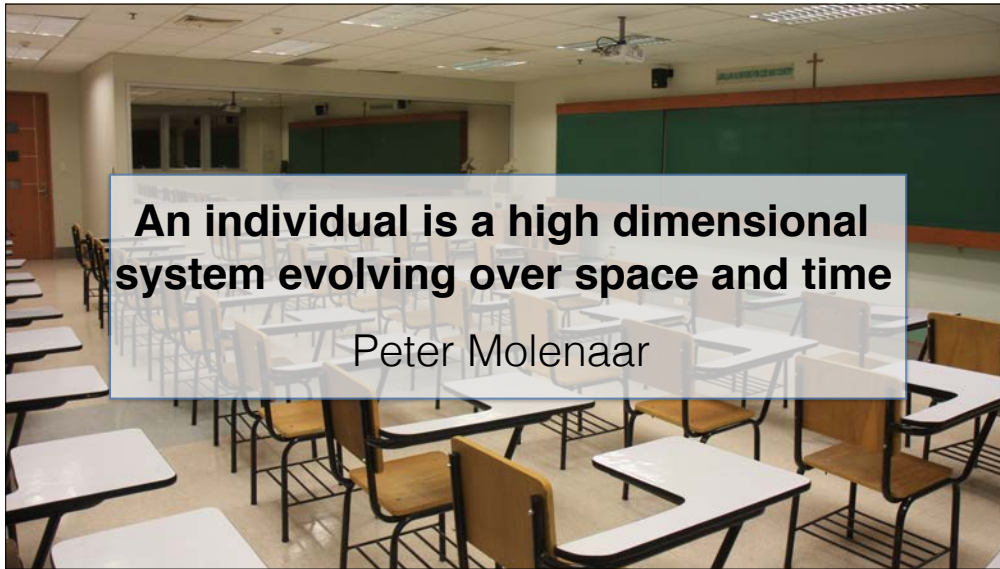

Laboratory for the Science of the Individual
At the Harvard Graduate School of Education



Home People ▾ Projects ▾ Publications Links

The Laboratory for the Science of the Individual at the Harvard Graduate School of Education is focused on developing new insights into human individuality and leveraging these findings to address longstanding issues of equity and excellence in education and society. To accomplish this work we collaborate with other laboratories within and outside of HGSE as well as the [Center for Individual Opportunity](#). For more information about our research see our paper in the Journal of Mind, Brain, and Education on [The Science of the Individual](#). For more about the big ideas see the recent Harvard Ed Magazine article [Beyond Average](#) or the book [The End of Average](#).



Myth of Average: Todd Rose's TEDx Talk

Watch Todd Rose talk about how a simple new way of thinking helps nurture individual potential.

AFFECTIVE NETWORKS:
THE **WHY** OF LEARNING

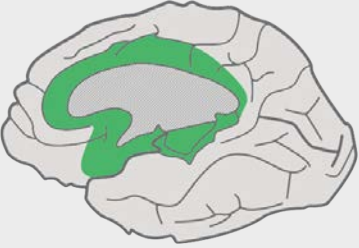

Varied means for engaging students

RECOGNITION NETWORKS:
THE **WHAT** OF LEARNING



Varied means of representing content

STRATEGIC NETWORKS:
THE **HOW** OF LEARNING



Varied ways for students to express what they know

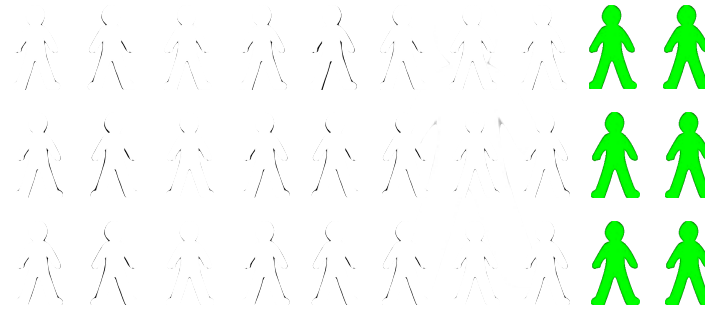

In a school setting where the focus is on fixed pace group instruction, only 20% of students ever successfully achieve mastery.

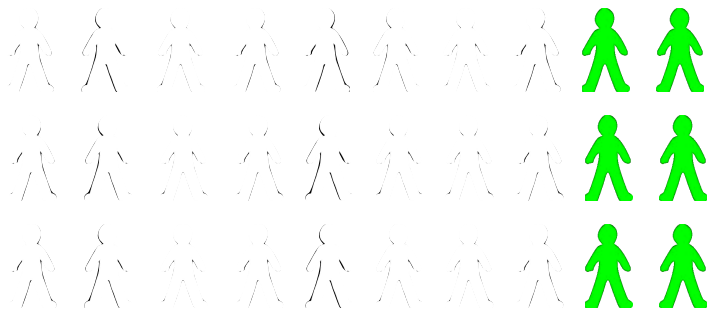

In a school setting where the focus is on fixed pace group instruction, only 20% of students ever successfully achieve mastery.

Students formally diagnosed with special needs

Students who mostly are



Students with significant additional learning needs

Students who are not mastering normative education

INSPIRED BY A PUBLIC SCHOOL STUDENT WITH DISABILITIES

COULD YOU PLEASE SHOVEL THE RAMP?

ALL THESE OTHER KIDS ARE WAITING TO USE THE STAIRS. WHEN I GET THROUGH SHOVELING THEM OFF, THEN I WILL CLEAR THE RAMP FOR YOU.

BUT IF YOU SHOVEL THE RAMP, WE CAN ALL GET IN!

© 2002 MICHAEL F. GIANGRECO. ILLUSTRATION BY KEVIN RUELLE PEYTRAL PUBLICATIONS, INC. 952-949-0707 WWW.PEYTRAL.COM

CLEARING A PATH FOR PEOPLE WITH SPECIAL NEEDS CLEARS THE PATH FOR EVERYONE!

"A RADIANT, UPLIFTING STORY."
—DANIEL O'NEILL, THE HOLLYWOOD REPORTER

WINNER
FULL FRAME
2011

WINNER
sundance
DIRECTING AWARD
2011

WINNER
SAN FRANCISCO
INTERNATIONAL
FILM FESTIVAL
2011

"DEEPLY MOVING."
A WARM TESTAMENT TO A FAMILY'S LOVE AND RESILIENCE."
—LIZZY DODD, VARIETY

FROM ACADEMY AWARD-WINNING DIRECTOR
ROGER ROSS WILLIAMS

LIFE, ANIMATED

BASED ON THE BEST-SELLING BOOK BY RON SUSSKIND



NOW ON ITUNES AND ON DEMAND
NOW IN THEATERS

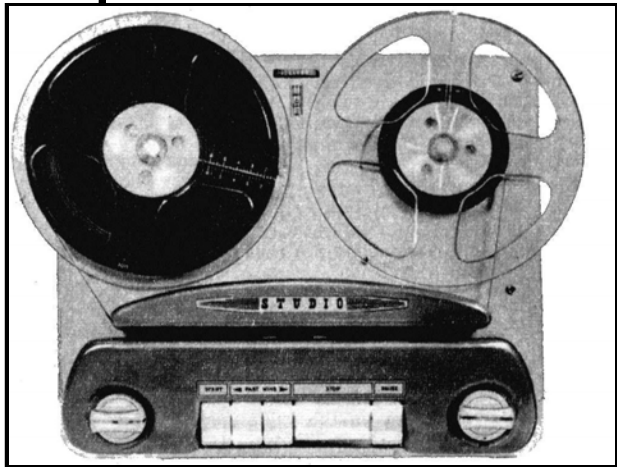

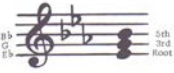



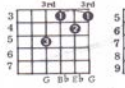
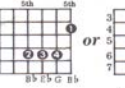
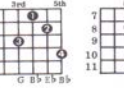
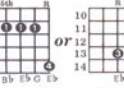

E^b Major  *Symbol (E^b)*





Melody Chords

| | | | | |
|---|---|---|---|---|
|  |  |  |  |  |
|---|---|---|---|---|



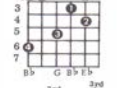
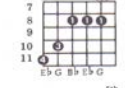

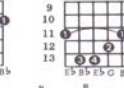
Inside Chords

| | | | | |
|---|---|---|---|---|
|  |  |  |  |  |
|---|---|---|---|---|

Rhythm Chords

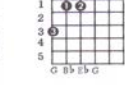
| | | | | |
|---|---|---|---|---|
|  |  |  |  |  |
|---|---|---|---|---|

Bottom 4 String Chords

| | | | | |
|---|---|---|---|---|
|  |  |  |  |  |
|---|---|---|---|---|

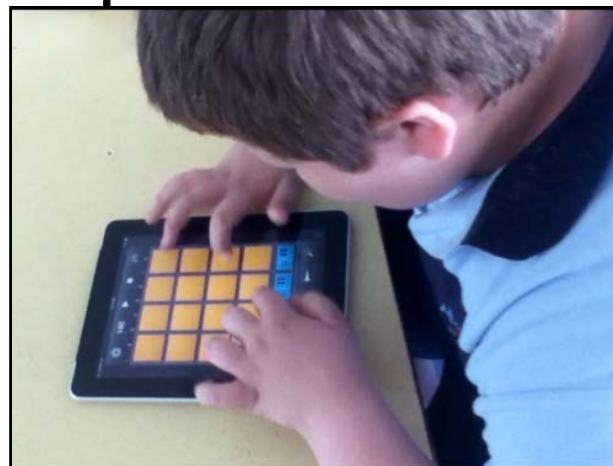

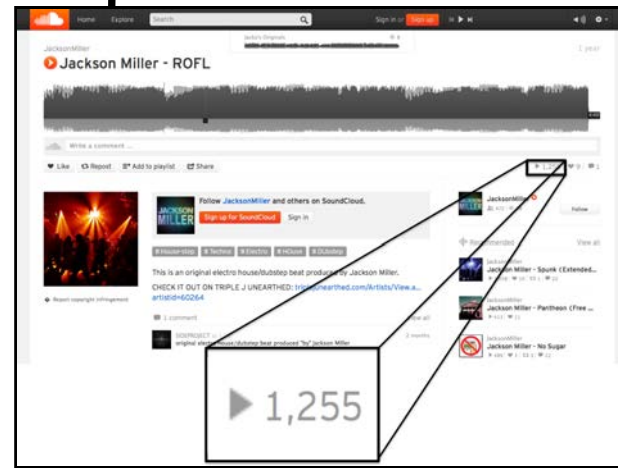
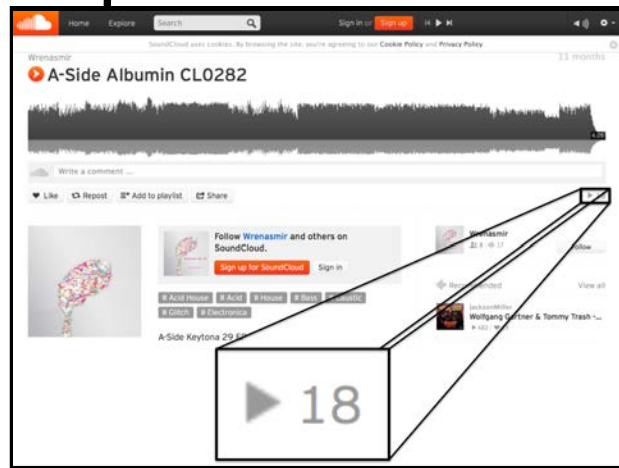



STUDENT NAME

What people like and admire about me:



What makes me happy:

How I want to be supported:

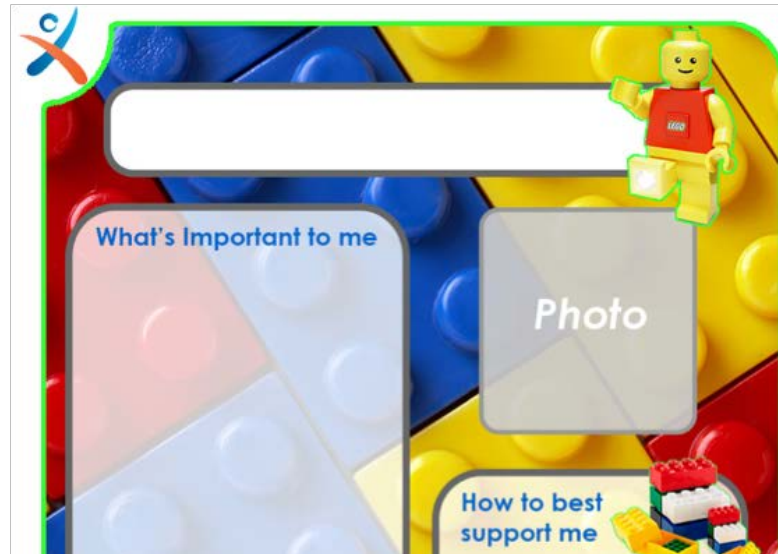

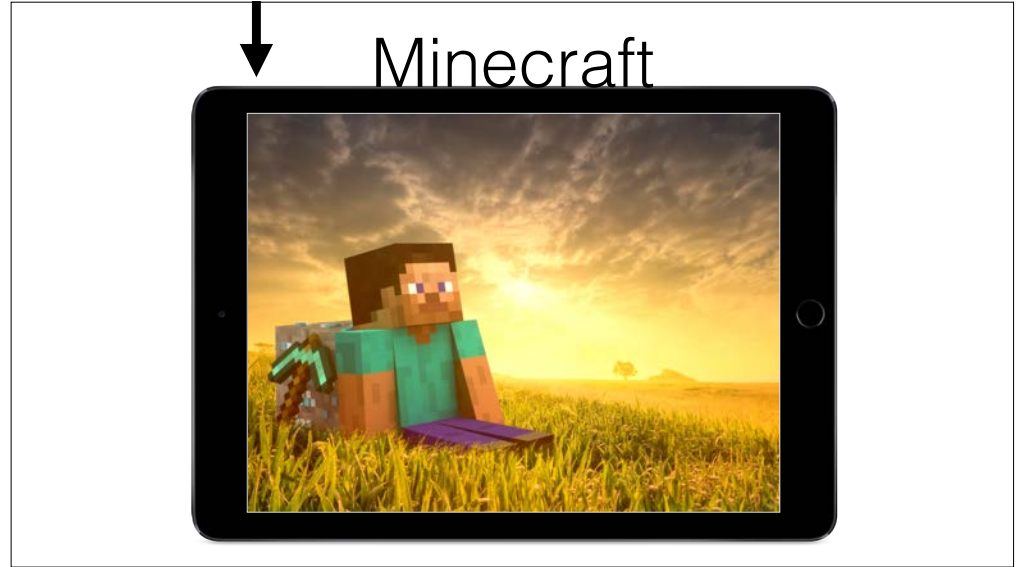

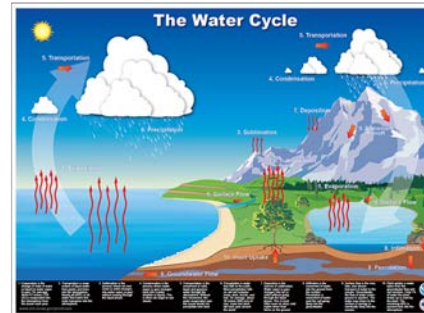
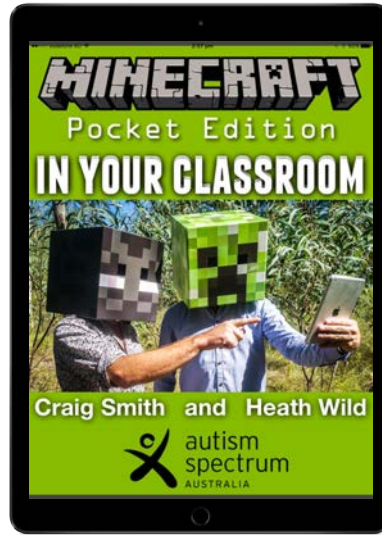
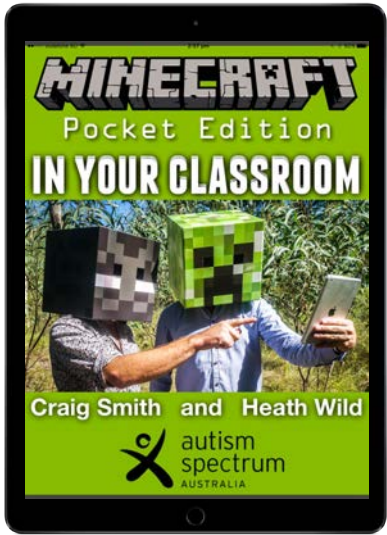

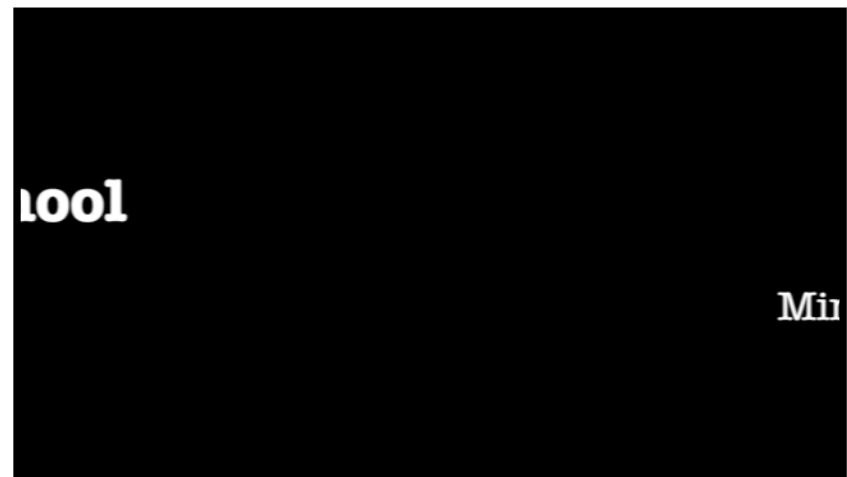
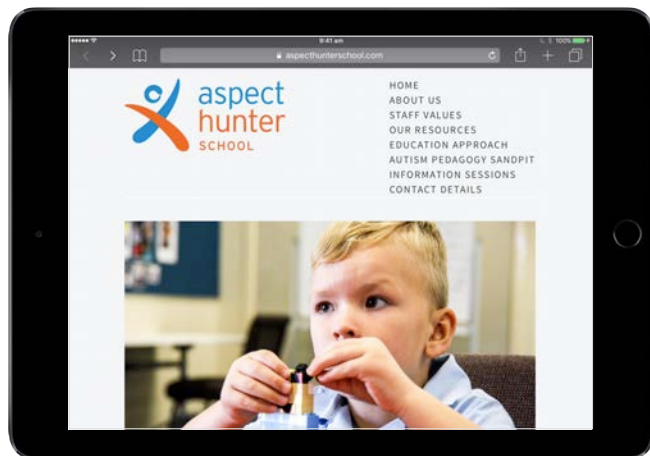
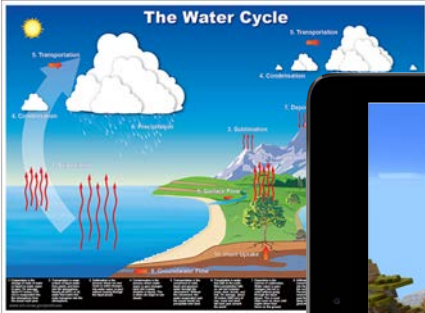



Inside Out

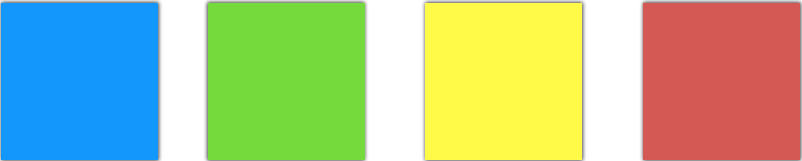
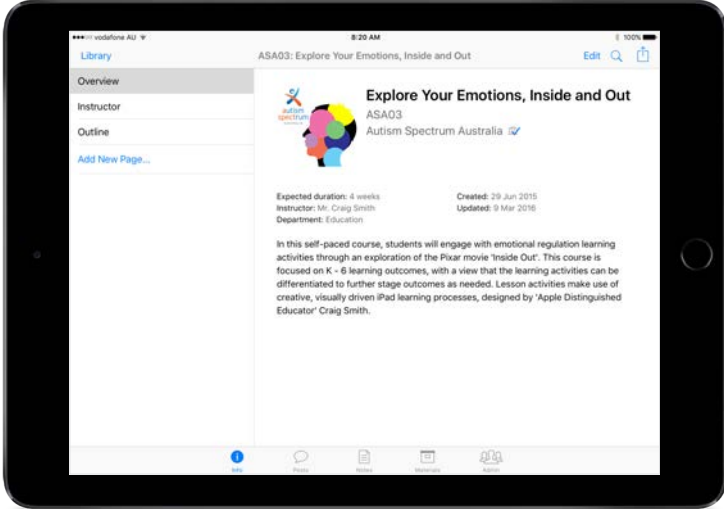

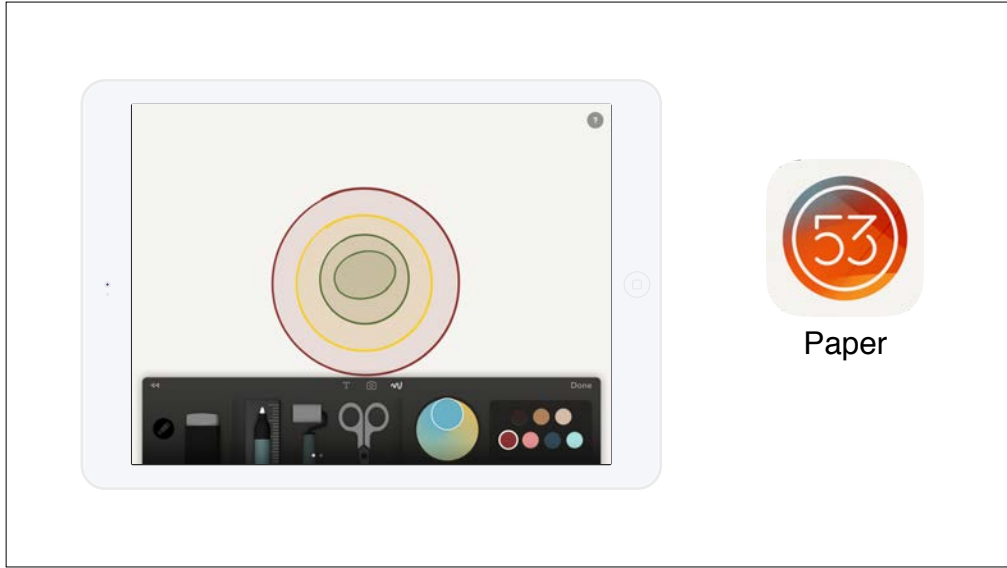
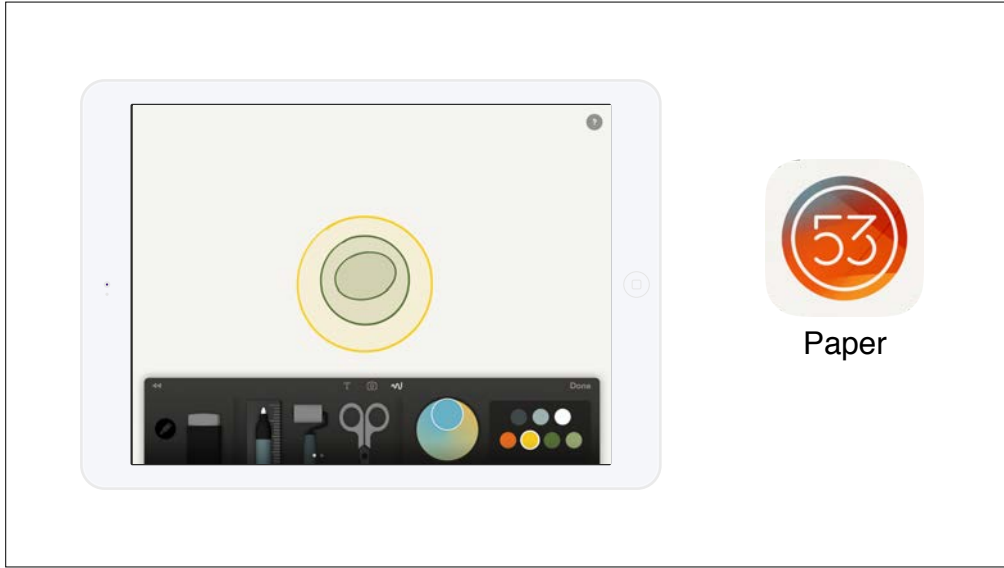
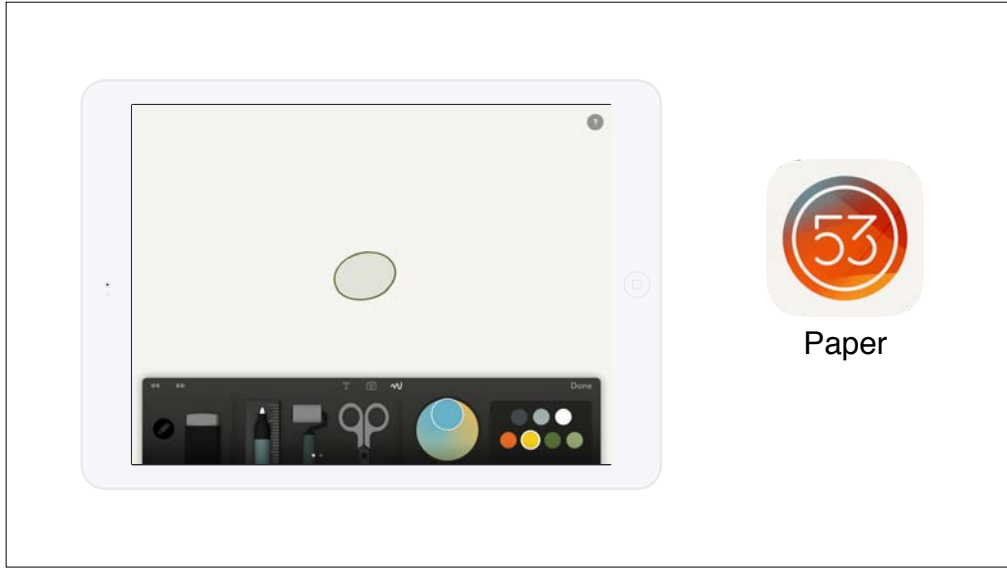
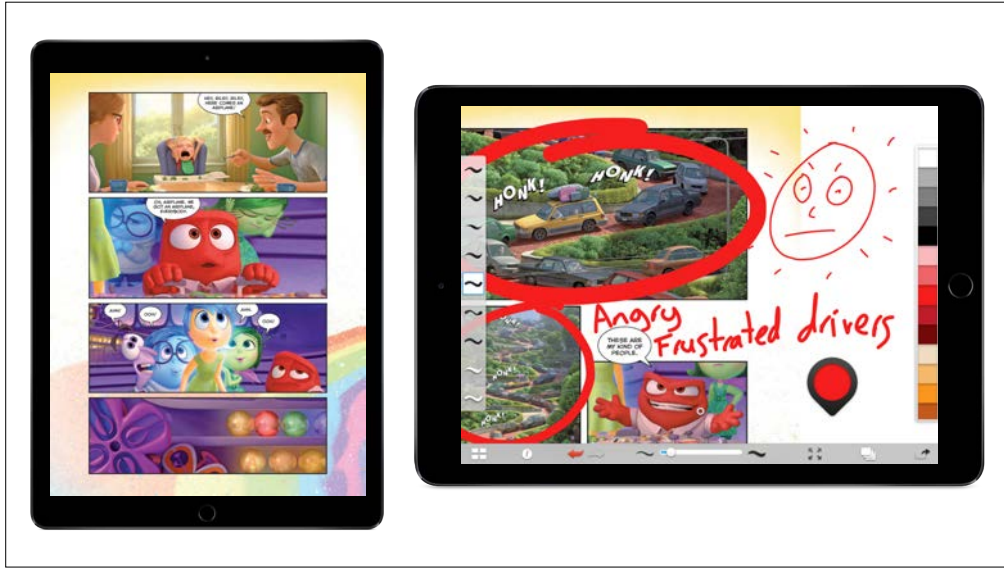

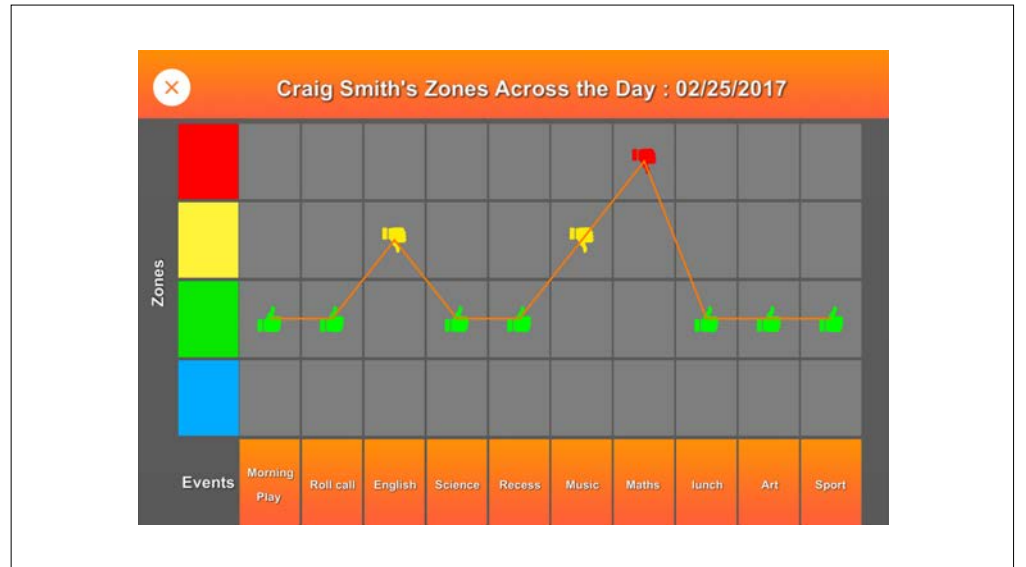
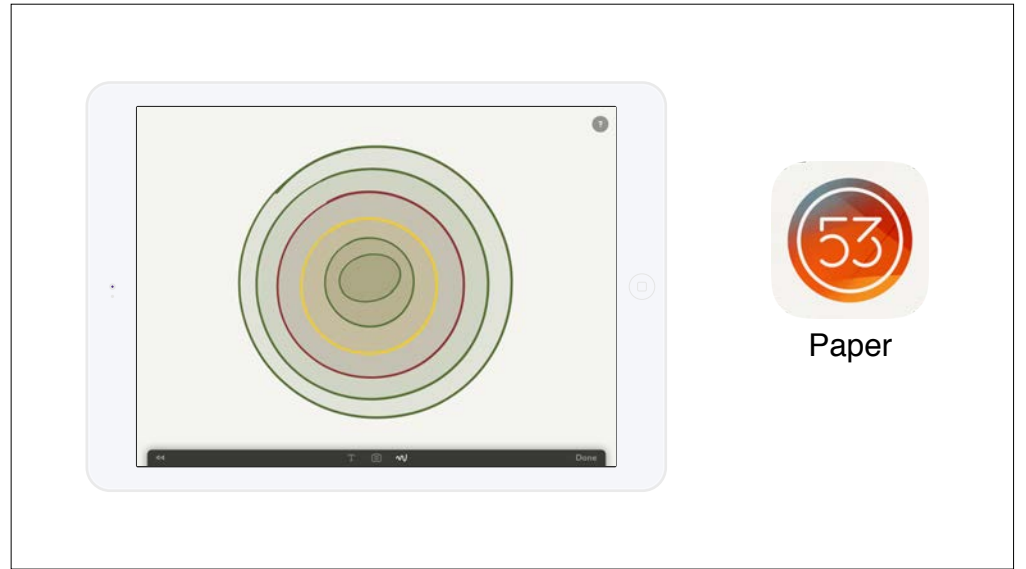

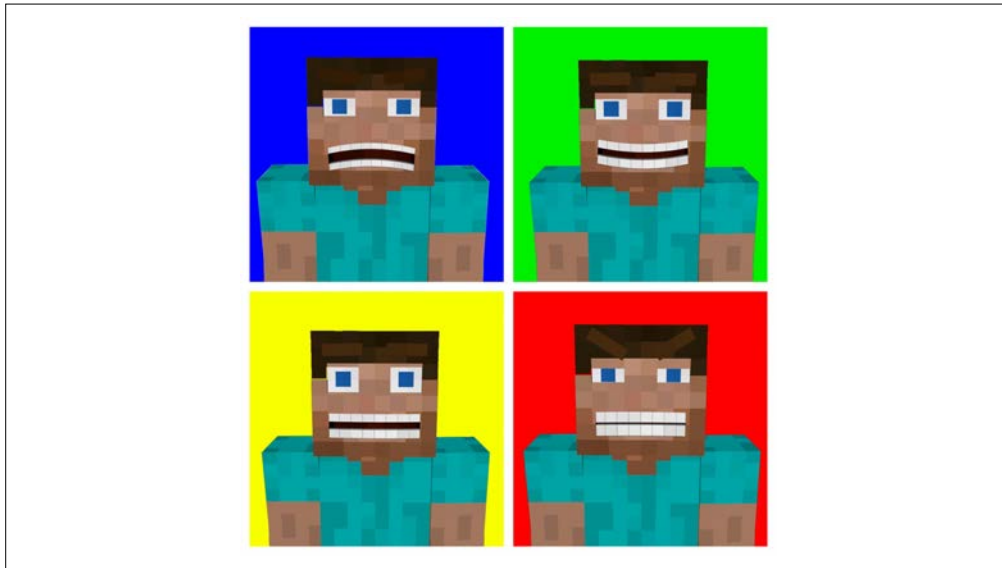
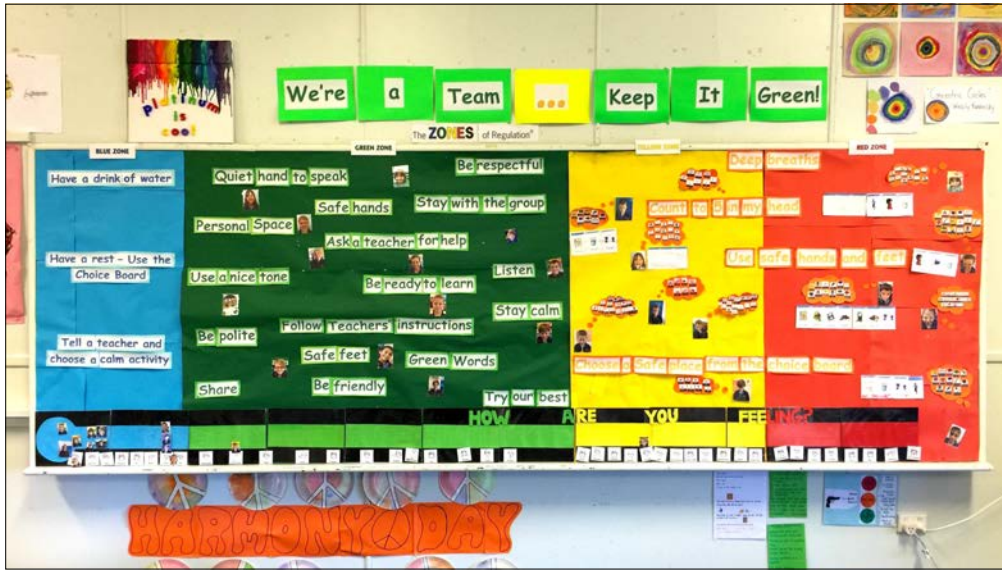

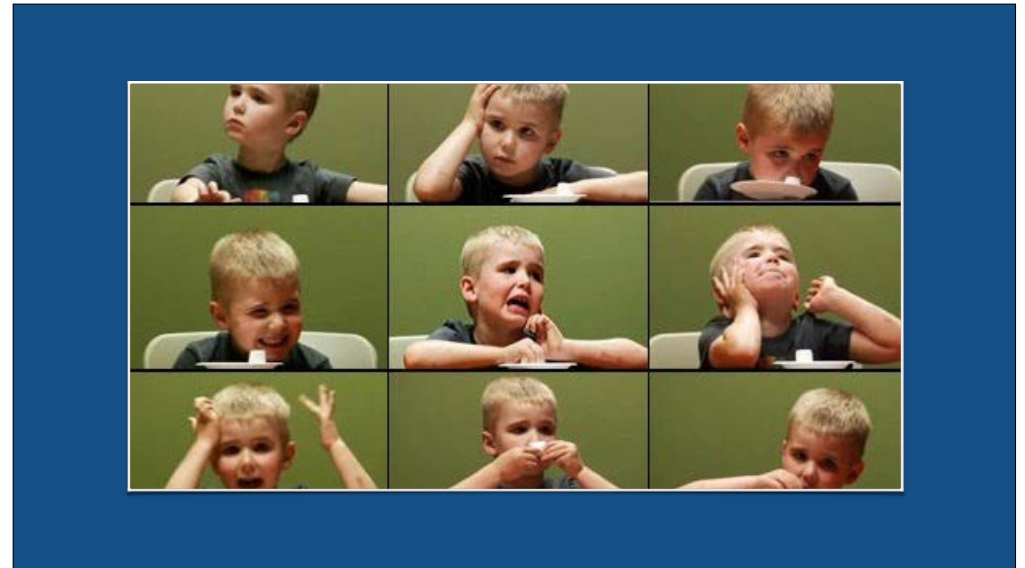

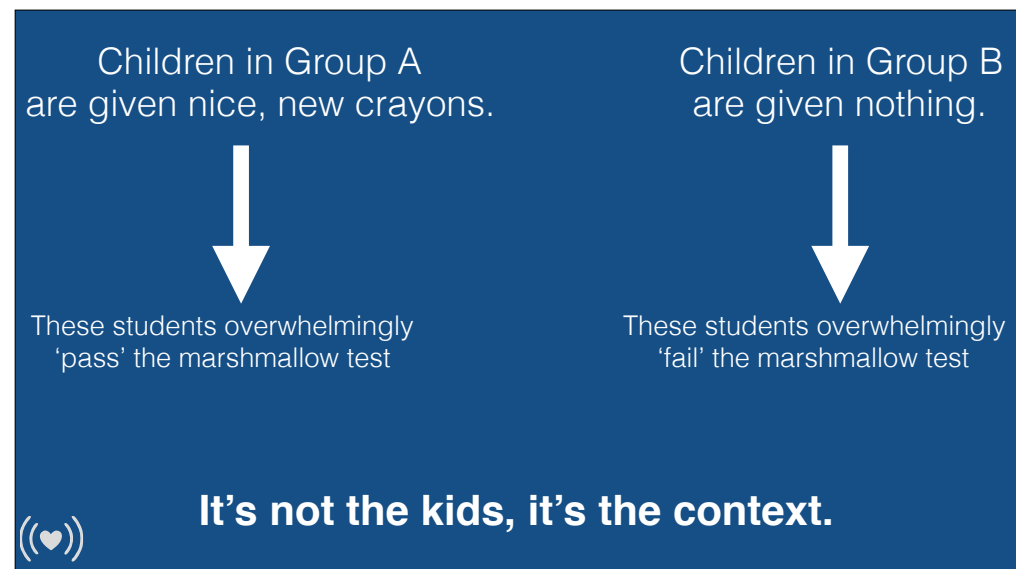
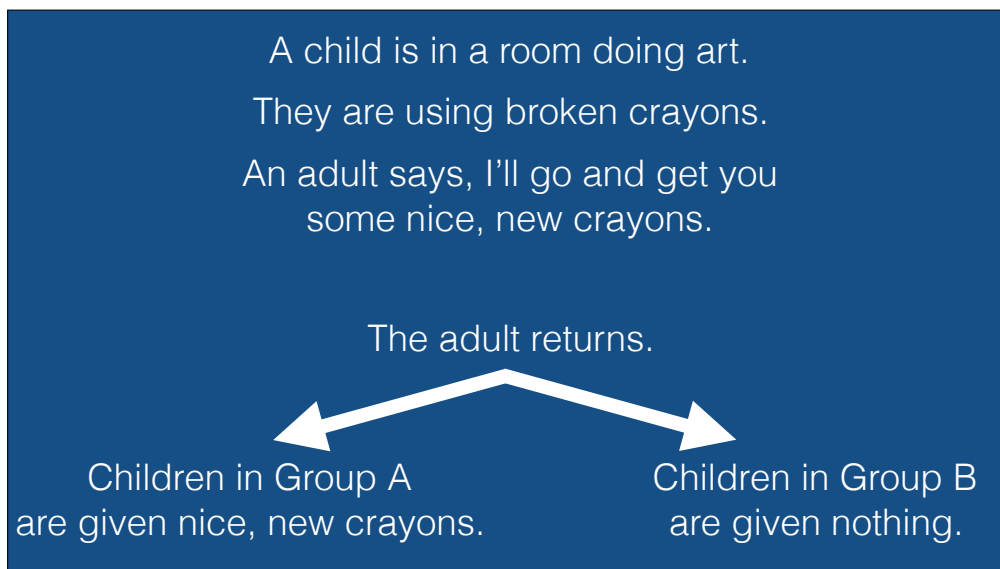
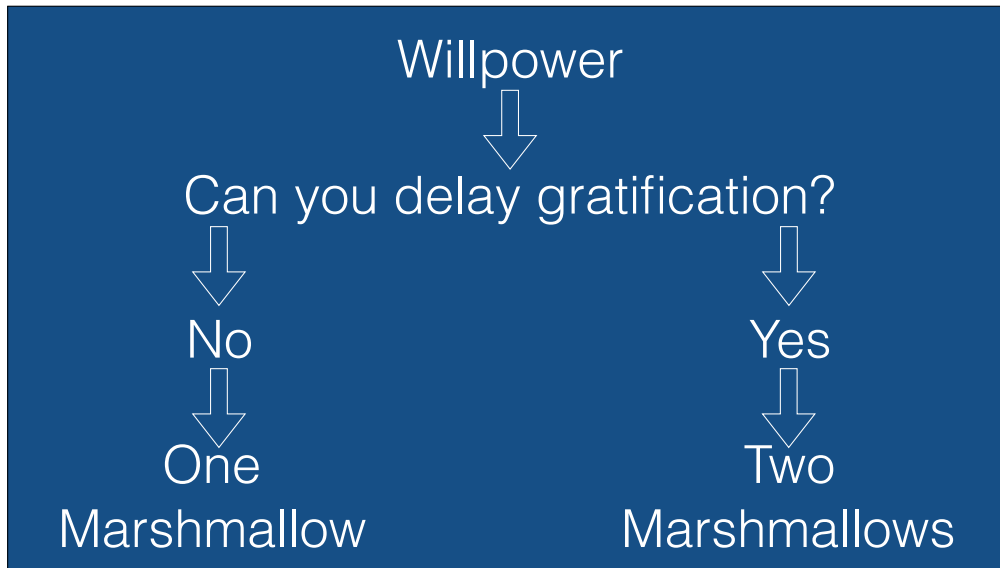

If... Then

If Craig is in the classroom
Then he is playful and silly.

If Craig is on the playground
Then he is careful and quiet.

If Craig is in maths class
Then he thinks by doodling.

If Craig is in english class
Then he thinks by talking.

If Craig is told he is wrong
Then he will become
frustrated until he
can show he is right.

If... Then

statements help us to understand
that students are a complex
mix of environment and self.

If... Then

This helps us to understand student
behavioural needs in the classroom, and it
helps us to understand how to help our
students to better recognise these 'If...Then'
statements within themselves.

Global Accessibility Awareness Day



#GAAD



Two personalised learning goals



How can you get to know your students better?

Use one page profiles and take the time to learn about what your students are passionate about.



Consider 'If...Then' prompts.

Consider how the environment a child is in can impact on how they respond, and ways of considering this in your classroom and school.



Thank you.